

Rivet Series

FRAMA

Index

3 FRAMA Studio

5 Rivet Series

6 Products

Rivet Box Table

Rivet Case

Rivet Side Table

Rivet Typecase

Rivet Shelf

Rivet Cart

13 Contact



Since the first collection in 2011, FRAMA has embraced an organic and collaborative approach to design equally inspired by the old and the new, by digital technologies and analog traditions. The naturalistic, hands-on approach to design and production has allowed for creating a unified aesthetic across a growing range of product collections.



The Rivet Series

Based on the traditional hand construction technique of riveting, the Rivet Series is made of laser-cut raw aluminum sheets; hereafter joined together by hand using a basic hammer tool. A celebration of the purity of aluminum left untreated with the material's honesty in mind.



Rivet Box Table

RIVET BOX TABLE

Product	Rivet Box Table
Design	Jonas Trampedach
Material	Untreated Aluminum
Dimensions	H48 W32.8 D32.8

Untreated Aluminum

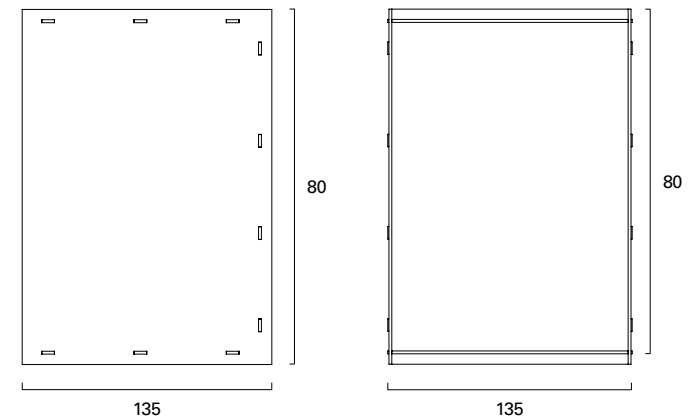

Rivet Case

RIVET CASE

Product	Rivet Case
Design	Jonas Trampedach
Material	Untreated Aluminum
Dimensions	H48.1 W98.3 D33.8

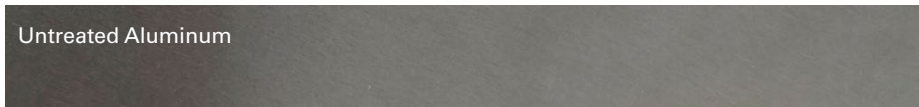

Top View

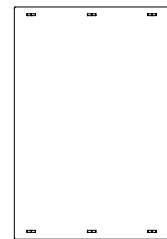
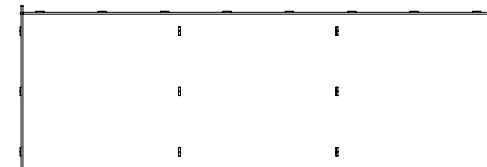

33.8

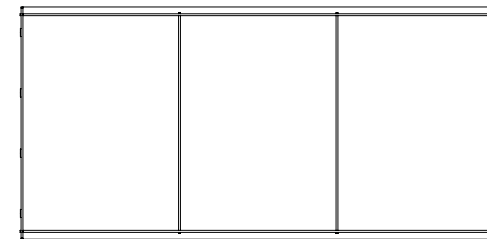

98.3

48.1

Rivet Side Table

RIVET SIDE TABLE

Product	Rivet Side Table
Design	Jonas Trampedach
Material	Untreated Aluminum
Dimensions	Ø51.3 H40

Untreated Aluminum

Top View

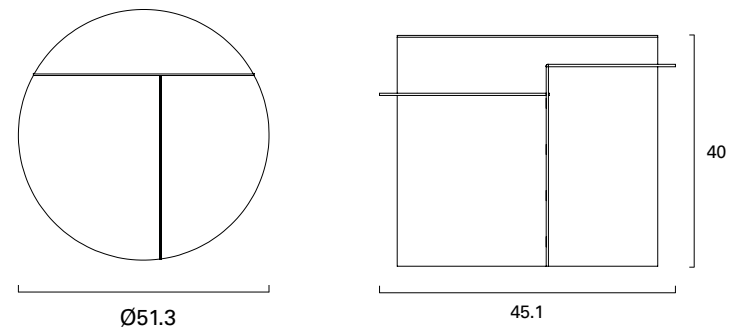

Rivet Typecase

RIVET TYPECASE

Product	Rivet Typecase
Design	Jonas Trampedach
Material	Untreated Aluminum
Dimensions	H44.6 W44.6 D16.1

Untreated Aluminum

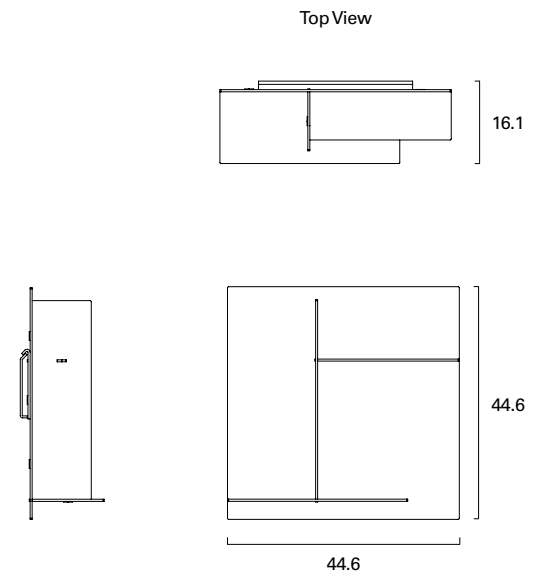

Rivet Shelf

RIVET SHELF SMALL

Product Rivet Shelf Small
Design Jonas Trampedach
Material Untreated Aluminum
Dimensions H20.6 W87.6 D24.4

RIVET SHELF LARGE

Product Rivet Shelf Large
Design Jonas Trampedach
Material Untreated Aluminum
Dimensions H20.6 W119 D24.4

Untreated Aluminum

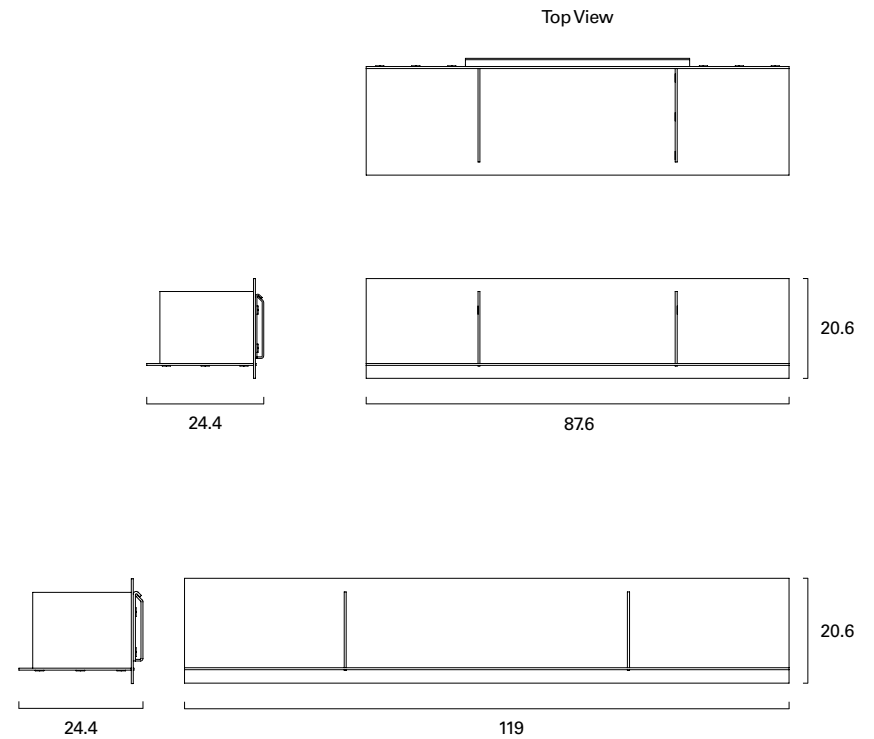

Rivet Cart

RIVET CART

Product	Rivet Cart
Design	Jonas Trampedach
Material	Untreated Aluminum
Dimensions	H60.6 W32.8 D33.8

Untreated Aluminum

Top View

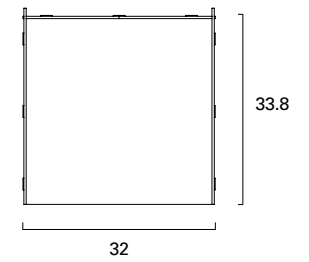

Front View

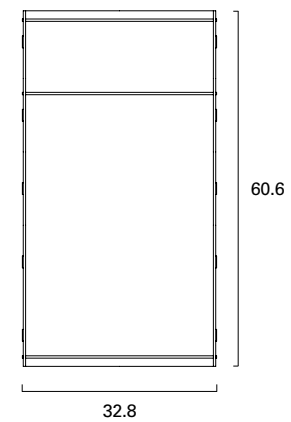

Side View

